



HUBDISK-2 Features

- 2 in. outside diameter
- 64 to 10,000 CPR (256 to 40,000 PPR)



HUBDISK-2 Product Description

US Digital offers a wide variety of standard HubDisk assemblies (optical encoder disk attached to an aluminum hub) to aid mounting onto a shaft. Encoder disks may also be ordered as stand-alone items. The rotary encoder disks are made from 0.007 in. thick Mylar polyester film, and the material allows for a -40C to 100C temperature range. The disk on the HubDisk assembly comes attached with the emulsion side up when the disk text is right-reading.



HUBDISK-2 consists of a precision machined aluminum hub fastened to a 2 in. diameter optical encoder disk (DISK-2 (<https://www.usdigital.com/products/encoders/incremental/modules/components/disk-2/>)). One or two .050 in. flat-to-flat set screws (depending on the hub's bore size) are used to fasten the hub to a shaft. The HubDisk assembly is available with bore sizes ranging from 2mm to 1 in. All HubDisk assembly bores are held to a very tight tolerance defined by US Digital Technical Bulletin Shaft and Bore Tolerances TB1001 (<https://www.usdigital.com/support/resources/reference/technical-docs/technical-bulletins/shaft-and-bore-tolerances-tb1001/>).

Mechanical Drawings

HUBDISK-2 2" Transmissive Rotary Codewheel (Bores 12mm & Greater)

RELEASE DATE: 05/13/2020

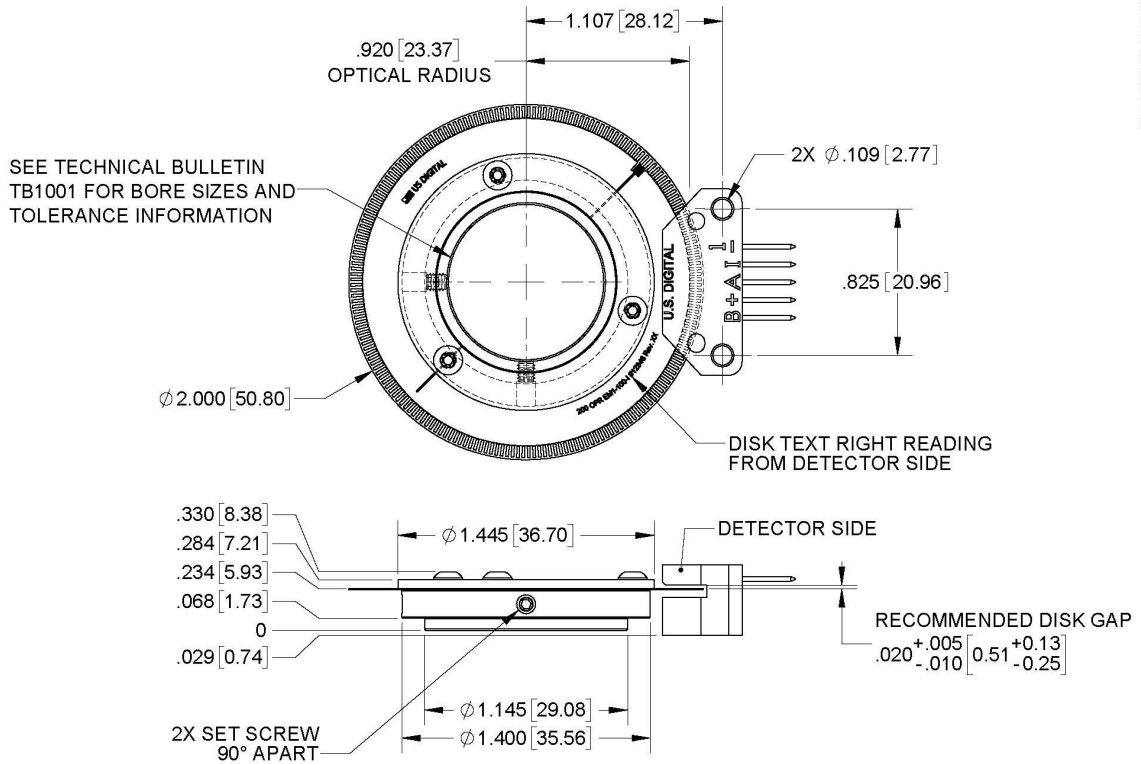

US DIGITAL 1400 NE 136th Avenue
Vancouver, Washington 98684, USA

info@usdigital.com
www.usdigital.com

Local: 360.260.2468
Toll-free: 800.736.0194

UNITS: INCHES [MM]
METRIC SHOWN FOR REFERENCE ONLY

HUBDISK-2 2" Transmissive Rotary Codewheel (Bores 2mm - 10mm)

RELEASE DATE: 05/19/2020

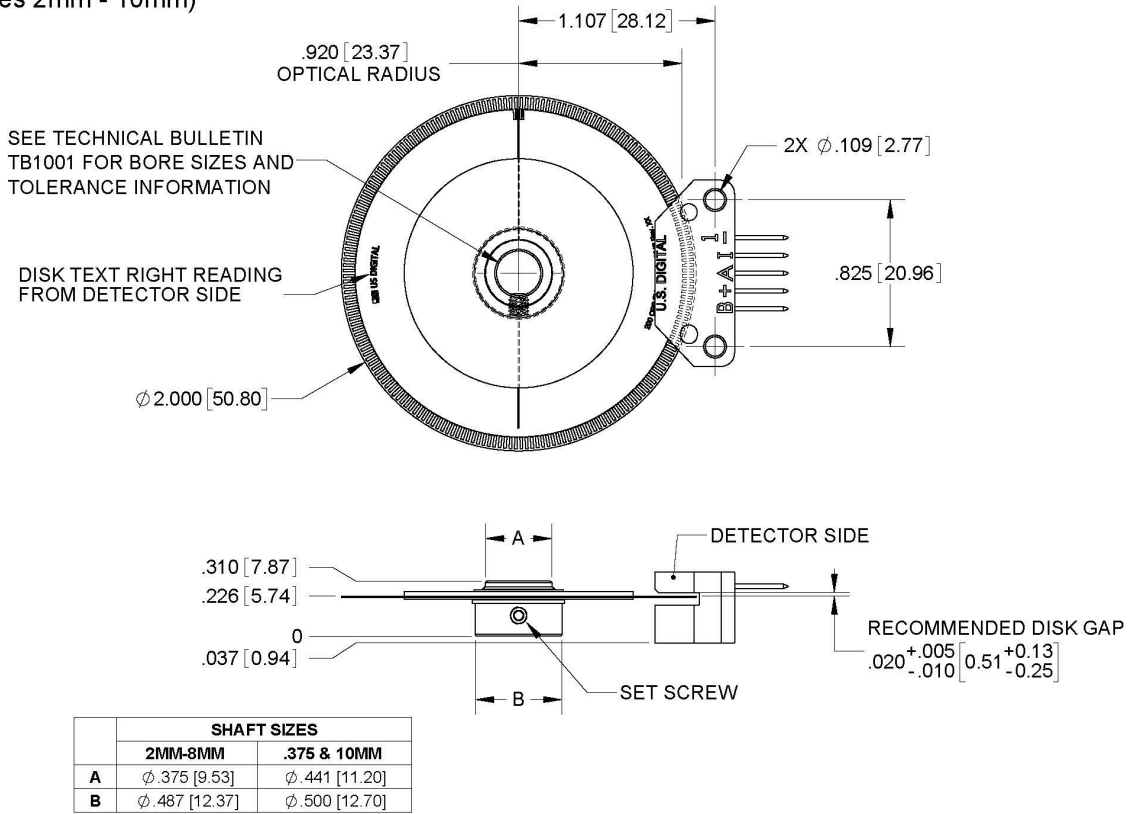

US DIGITAL 1400 NE 136th Avenue
Vancouver, Washington 98684, USA

info@usdigital.com
www.usdigital.com

Local: 360.260.2468
Toll-free: 800.736.0194

UNITS: INCHES [MM]
METRIC SHOWN FOR REFERENCE ONLY

Specifications

SPECIFICATIONS

Temperature Range	-40C to 100C
Hub Set Screw Torque	2-3 in-lbs
Outside Disk Diameter (OD)	2" \pm 0.010 in.
Bore Diameter Tolerance	See Technical Bulletin TB1001 (https://www.usdigital.com/support/resources/reference/technical-docs/technical-bulletins/shaft-and-bore-tolerances-tb1001/)
Disk Thickness	0.007"



TECHNICAL BULLETINS

TITLE	DOWNLOAD
Technical Bulletin TB1001 - Shaft and Bore Tolerances	Download (https://www.usdigital.com/support/resources/reference/technical-docs/technical-bulletins/shaft-and-bore-tolerances-tb1001/)

COMPATIBLE ENCODER MODULES

CPR	2" HUBDISK Non-Index	MODULE Non-Index	2" HUBDISK Index	MODULE Index
64	HUBDISK-2-64-*-NE	EM1-1-32-N		
100	HUBDISK-2-100-*-NE	EM1-1-50-N	HUBDISK-2-100-*-IE	EM1-1-50-I
200	HUBDISK-2-200-*-NE	EM1-1-100-N	HUBDISK-2-200-*-IE	EM1-1-100-I
400	HUBDISK-2-400-*-NE	EM1-1-200-N	HUBDISK-2-400-*-IE	EM1-1-200-I
800	HUBDISK-2-800-*-NE	EM1-1-400-N	HUBDISK-2-800-*-IE	EM1-1-400-I
500	HUBDISK-2-500-*-NE	EM1-2-500-N	HUBDISK-2-500-*-IE	EM1-2-500-I
1000	HUBDISK-2-1000-*-NE	EM1-2-1000-N	HUBDISK-2-1000-*-IE	EM1-2-1000-I
1024	HUBDISK-2-1024-*-NE	EM1-2-1024-N	HUBDISK-2-1024-*-IE	EM1-2-1024-I
1800	HUBDISK-2-1800-*-NE	EM1-2-1800-N	HUBDISK-2-1800-*-IE	EM1-2-1800-I
2000	HUBDISK-2-2000-*-NE	EM1-2-2000-N	HUBDISK-2-2000-*-IE	EM1-2-2000-I
2048	HUBDISK-2-2048-*-NE	EM1-2-2048-N	HUBDISK-2-2048-*-IE	EM1-2-2048-I
2500	HUBDISK-2-2500-*-NE	EM1-2-2500-N	HUBDISK-2-2500-*-IE	EM1-2-2500-I
3600			HUBDISK-2-3600-*-IE	EM2-2-3600-I
4000			HUBDISK-2-4000-*-IE	EM2-2-4000-I
4096			HUBDISK-2-4096-*-IE	EM2-2-4096-I
5000			HUBDISK-2-5000-*-IE	EM2-2-5000-I
7200			HUBDISK-2-7200-*-IE	EM2-2-7200-I
8000			HUBDISK-2-8000-*-IE	EM2-2-8000-I
8192			HUBDISK-2-8192-*-IE	EM2-2-8192-I
10000			HUBDISK-2-10000-*-IE	EM2-2-10000-I

*Represents the bore size

Notes



HUBDISK-2 2 in. Transmissive Rotary Disk

- US Digital® warrants its products against defects in materials and workmanship for two years. See complete warranty (<https://www.usdigital.com/company/warranty>) for details.

Configuration Options

HUBDISK-2	CPR (Cycles Per Revolution)	Bore Size	Index
	64	079 (2.0mm)	IE (Index)
	100	118 (3.0mm)	I (Index)
	200	125 (1/8")	NE (Non-Index)
	400	156 (5/32")	
	500	157 (4.0mm)	
	512	188 (3/16")	
	800	197 (5.0mm)	
	1000	236 (6.0mm)	
	1024	250 (1/4")	
	1800	276 (7.0mm)	
	2000	313 (5/16")	
	2048	315 (8.0mm)	
	2500	375 (3/8")	
	3600	394 (10.0mm)	
	4000	472 (12.0mm)	
	4096	500 (1/2")	
	5000	551 (14.0mm)	
	7200	625 (5/8" Bore)	
	8000	750 (3/4" Bore)	
	8192	787 (20.0mm)	
	10000	875 (7/8")	
		984 (25.0mm)	
		1000 (1")	

PLEASE NOTE: This chart is for informational use only. Certain product configuration combinations are not available. Visit the HUBDISK-2 product page (<https://www.usdigital.com/products/HUBDISK-2>) for pricing and additional information.